

Name: Elea PF/55

Design: Joana Bover / 2013

Typology: Ceiling lamp



Environment: Indoor

Technical description:

Polyurethane, circular ceiling mount finished in brilliant lacquer with optical glass lower diffuser. Available in two ceiling sizes, and also as a pendant fixture. Direct wire electrical connection. Elea is not a customizable product. For special finishings the RAL number is needed, and the minimum quantity is 3 units.



Lamps description



-  Grounding: compulsory
-  4 x 20 W E26 Triple CFL
-  4 x 10 W E26 A19 LED

Voltage: 120V~60Hz

 1 Box 26.38 x 26.38 x 9.84 inches

Vol.: 3.9623 ft<sup>3</sup>

Weight: 17.64 lbs

Certifications:  

 Photometrics made according to the position the lights are shown in the catalogue and price list.

Ref Finishings

- 510232401U White Brilliant Lacquer
- 510232423U Black Brilliant Lacquer
- 510232422U Red Brilliant Lacquer

Finishing: Brilliant lacquer finish

Material: Polyurethane

Optical glass diffuser

Not Customizable

Measures

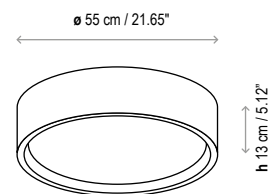

Elea PF/55

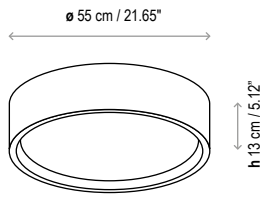

Elea PF/85

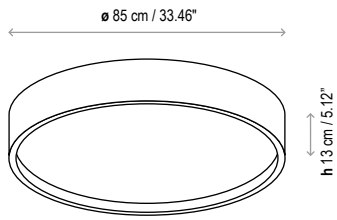

Elea S/55

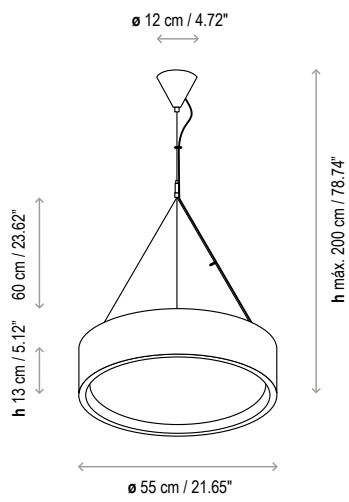

Elea S/85

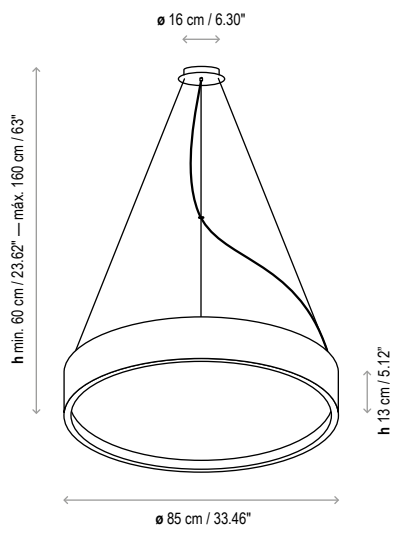

Elea S/95

