

Name: Nón Lá A 01

Design: Jorge Pensi Design Studio / 2015

Typology: Wall lamp









Environment: Indoor

Technical description:

Lightweight asymmetrical conical LED wall sconce made of aluminum finished in Chrome, Copper and White lacquer. Polycarbonate diffuser covering LED panel. Light reflects on wall as well as through the aperture and slot on the shade. Meets ADA standards. Can be ceiling mounted. Dimming system: TRIAC.



Lamps description

	Grounding: compulsory
	Ready for mounting on normally flammable surface
	TRIAC dimming system
	10,5 W LED Led: 35 x 0,3 W = 10,5 W Lumens: 1200 lm CRI: 90 Degrees Kelvin: 2700 <sup>º</sup>
Voltage: 230V~50Hz	
	1 Box 29 x 29 x 22 cm
Vol.: 0,0185 m <sup>3</sup> Weight: 1,82 kg	
Certifications:  	
	Photometrics made according to the position the lights are shown in the catalogue and price list.

Ref                      Finishings

3320100601	White Brilliant Lacquer
3320100606	Chrome
3320100690	Brilliant Copper
<hr/>	
3320101301	Triac White Brilliant Lacquer
3320101306	Triac Chrome
3320101390	Triac Brilliant Copper
<hr/>	
Not Customizable	

Measures

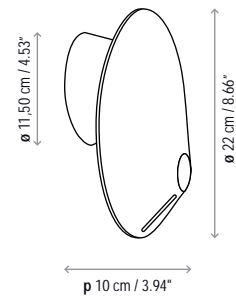

Nón Lá A 01

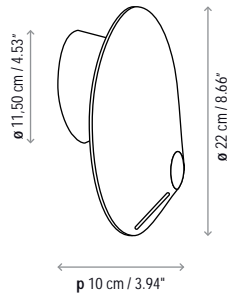

Nón Lá A 02

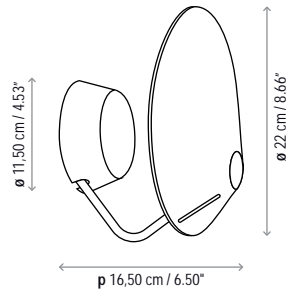

Nón Lá A 03

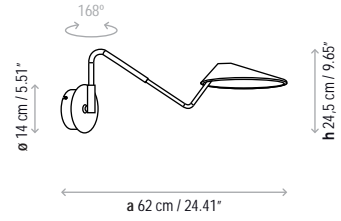

Nón Lá A 04

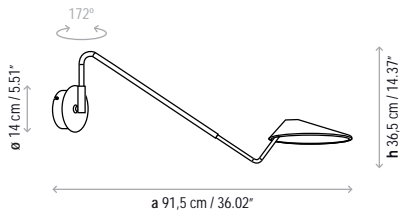

Nón Lá T

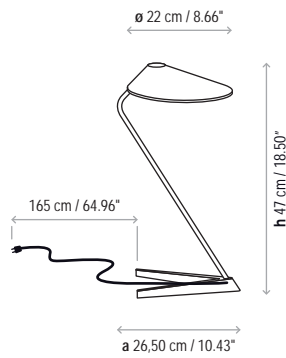

Nón Lá S

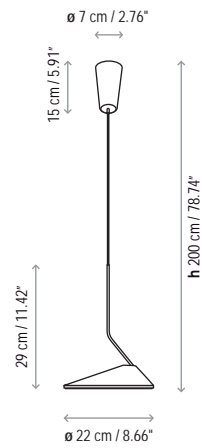

Nón Lá Set 3 Circular

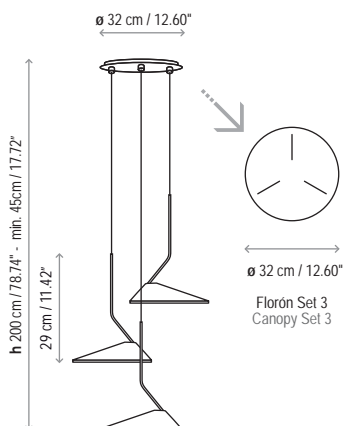

Nón Lá Set 3 Rectangular

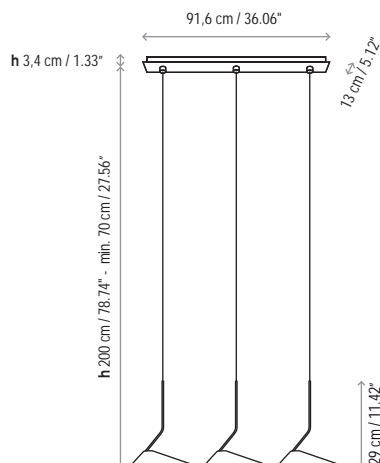

Nón Lá Set 6 Circular

