

Oval M/47

Design / Diseño:
Joana Bover / 2007

Typology: Table lamp
Tipología: Mesa

Environment: Indoor
Ambiente: Interior

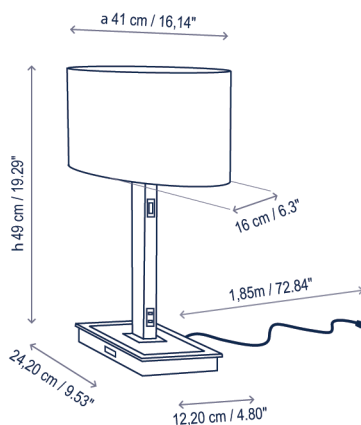

Technical description / Descripción técnica:

Net Weight: 5.56 lbs
Peso Neto: 5.56 lbs

1 Box/Caja
26.38 x 26.38 x 9.84 inches | 3.9632 ft³
Gross Weight / Peso bruto: 12.39 lbs

Materials: Brass, Glass, Iron
Materiales: Latón, Cristal, Hierro

Upper diffuser: Black glass
Difusor superior: Cristal negro

Transparent electrical cable
Cable eléctrico transparente



On/Off switch and outlet for type A plug located on the stem.
USB port located on the base.
Interruptor de encendido y enchufe para clavija tipo C situado en mástil.
Entrada conector USB en la base.

Shade GWF1 / Hilo incandescente pantalla

Ribbon / Cinta: 960°
Cotton / Cotonet: 800°

USB: 5V 1A

MAX. 2 Amp. 230V~

Customizable
Personalizable

Bulbs not included
Bombillas no incluidas

Certifications
Certificaciones

Spare parts / Recambios:

R21250D Diffuser glass / Difusor cristal
R21250B Base glass / Base cristal

Lamps description / Descripción lámpara:

120V 60Hz | DRY | IP-20 | 1 x 60 W E26 A15 INC | 1 x 5 W E26 A15 LED | USB

Ref	Finishing / Acabados	Ean13
2125023USBU/P551D	Chrome Black Glass White Translucent Ribbon Shade Cromo Cristal Negro Pantalla Cinta Translúcida Blanca	8435493720470
2125023USBU/P552D	Chrome Black Glass Cream Translucent Ribbon Shade Cromo Cristal Negro Pantalla Cinta Translúcida Crema	8435493720487
2125023USBU/P553D	Chrome Black Glass Black Translucent Ribbon Shade Cromo Cristal Negro Pantalla Cinta Translúcida Negra	8435493720494
2125023USBU/P554D	Chrome Black Glass White Cotton Shade Cromo Cristal Negro - Pantalla Cotonet Blanco	8435493720500
2125017USBU/P551D	Nickel Black Glass White Translucent Ribbon Shade Níquel Cristal Negro - Pantalla Cinta Translúcida Blanca	8435493720432
2125017USBU/P552D	Nickel Black Glass Cream Translucent Ribbon Shade Níquel Cristal Negro - Pantalla Cinta Translúcida Crema	8435493720449
2125017USBU/P553D	Nickel Black Glass Black Translucent Ribbon Shade Níquel Cristal Negro - Pantalla Cinta Translúcida Negra	8435493720456
2125017USBU/P554D	Nickel Black Glass White Cotton Shade Níquel Cristal Negro - Pantalla Cotonet Blanco	8435493720463

bover
barcelona lights

1231 Collier Road,
Suite C
Atlanta, GA 30318
United States

T. +1 (404) 924 2342
info@boverusa.com
www.boverusa.com

Family / Familia: Oval

